



HEXOLOY[®]

SiC Ceramic Materials
for Design of
High-Performance
Applications

CARBORUNDUM



A Century of Ceramic Technology

In the Beginning

No other company in the world has more expertise with silicon carbide than Carborundum. Carborundum invented it, developed numerous variations of it and makes more of it for high-performance components than anyone else in the world.

It started about 100 years ago. A struggling scientist, once employed by Thomas Edison, dreamed of becoming wealthy. What better way to riches, he reasoned, than by making artificial diamonds?

The determined young man attached one lead from a dynamo to a discarded plumber's bowl, filled the bowl with clay and powdered coke, inserted the other lead into the mix and threw the switch. Nothing seemed to happen. He was disappointed until he noticed a few bright specks on the end of the leads. When he drew one lead across a pane of glass, it cut like a diamond.

This young scientist, Dr. Edward Goodrich Acheson, had invented silicon carbide (SiC), the first man-made abrasive and substance hard enough to cut glass. Acheson's discovery became Carborundum, the trademark for silicon carbide and the name given to the company he started.



Today

Carborundum has earned a reputation for providing advanced, high-tech ceramic components to world-wide markets. These markets span multiple industries, requiring materials that are resistant to extreme temperature, thermal shock, abrasion and corrosion.



Hexoloy® Silicon Carbide - The Material Difference

More design engineers are finding out that traditional views of "ceramics" don't apply to Hexoloy silicon carbide products. Hexoloy products are opening new areas of application and design possibilities that are impractical with ductile metals and lesser ceramic materials.

Hexoloy sintered alpha silicon carbide is produced by pressureless sintering ultra-pure submicron powder derived from the original Acheson process. This powder is mixed with non-oxide sintering aids, then formed into complex shapes by a variety of methods and consolidated by sintering at temperatures above 2000°C (3632°F).

The sintering process results in a single-phase, fine-grain silicon carbide product that's very pure and uniform, with virtually no porosity. Whether submerged in corrosive environments, subjected to extreme wear and abrasive conditions, or exposed to temperatures in excess of 1400°C (2552°F), Hexoloy sintered alpha silicon carbide will outperform other commercially available ceramics or metal alloys, including superalloys.

These properties, plus the others outlined here, make Hexoloy silicon carbide ideal for applications such as chemical and slurry pump seals and bearings, nozzles, pump and valve trim, paper and textile equipment components, armor and more.

Think of all the applications where the properties of Hexoloy silicon carbide materials can make a big difference.

It's hard.

Hexoloy silicon carbide is one of the hardest high performance materials available, second only to diamonds.

Hardness (Knoop): 2800 kg/mm² at room temperature.

It's strong.

Actual use of Hexoloy silicon carbide parts indicates extremely high strength and excellent resistance to creep and stress rupture at temperatures up to 1650°C (3000°F) for sintered alpha silicon carbide.

Flexural strength (4 pt.): 55,000 psi (380 MPa)

Fracture toughness: 4.20 x 10³ lb/in²/√m

Modulus of elasticity (RT): 59 x 10⁶ lb/in² (410 GPa).

It's light.

Hexoloy silicon carbide weighs less than half as much as most metal alloys, 40 percent as much as steel and about the same as aluminum.

It's dense.

Densities of fired parts are consistently in excess of 98 percent of the theoretical density of Hexoloy silicon carbide - 3.21 g/cm³.

Density: 3.10 g/cm³ minimum.

It's wear resistant.

The extreme hardness and density of Hexoloy silicon carbide make it ideal for applications where parts are subject to high abrasion and sliding wear.

Specified wear rate (pin on disc):

SiC vs. SiC 1 x 10⁻⁹ mm²/kg.

Coefficient of friction (pin on disc): SiC vs. SiC 0.2.

It resists corrosion, oxidation and erosion.

The high density, low porosity and chemical inertness of Hexoloy silicon carbide permit it to function in environments of hot gases and liquids, in oxidizing and corrosive atmospheres, and in strong acids and bases, even at extremely high temperatures.

It resists heat.

The high thermal conductivity of Hexoloy silicon carbide, combined with its low thermal expansion, produces excellent thermal-shock resistance far better than tungsten carbide, aluminum oxide and RB silicon nitride. These properties make it a promising candidate to replace ductile metals in high-temperature applications.

It can be formed into complex shapes.

New developments by Carborundum researchers in the use of bonding agents and other additives now permit the mass production of complex shapes of Hexoloy silicon carbide by extrusion; pressure forming, with bidirectional or isostatic presses at room temperature; slip casting; and injection molding.

It requires minimum machining.

The as-fired surface finish of Hexoloy silicon carbide parts is excellent (about 64 microinches). This surface quality, combined with tight dimensional control, yields parts that should require little or no additional machining or finish grinding, depending on application.

It's up to you.

Where can you use Hexoloy silicon carbide materials? We hope the information in this brochure provides you with some new ideas. And we look forward to helping you explore the possibilities of applying this unique material to your particular requirements.



Physical Properties of Hexoloy® SiC Materials

		Hexoloy SiC Grades -Typical Values		
Physical Properties	Units	SA	SP	SG
Composition (phases)		SiC	SiC	SiC + C
Density	g/cm ³	3.10	2.95-3.05	2.95
Grain Size	microns	4-6	4-6	N/A
Hardness (Knoop)*		2800	3100	N/A
Flexural Strength	MPa	380		
4pt. @ RT**	x10 ³ lb/in ²	55	240	N/A
Compressive Strength @ RT	MPa	3900		N/A
	x 10 ³ lb/in ²	560	N/A	
Modulus of Elasticity @ RT	GPa	410	400	370†
	x 10 ⁶ lb/in	59		53†
Weibull Modulus (2 parameters)		8	19	N/A
Poisson Ratio		0.14	0.14	N/A
Fracture Toughness @ RT	MPa/m	4.60	4.60	4.60
Double Torsion & SENB	x10 ³ lb/in ² /in	4.20	4.20	4.20
Coefficient of Thermal Expansion	x 10 ⁻⁶ mm/mm°C	4.02	4.3	4.05†
RT to 700°C	x 10 ⁻⁶ in/in°F	2.20	3.0	2.22†
Max. Service Temp (air)	°C	1650	1650	1300†
	°F	3000	3000	2372†
Mean Specific Heat @ RT	J/gm·K	0.67	0.59	0.6†
Thermal Conductivity @ RT		125.6	110	120†
		72.6		69†
@ 200°C	W/mK	102.6		N/A
	Btu/ft h°F	59.3	N/A	
400°C		77.5		
		44.8	N/A	N/A
Permeability, RT to 1000°C		All impervious to gases over 31 MPa		
Electrical Resistivity @ RT***	ohm-cm	10 ² -10 ⁶		<1
@ 1000°C		0.01-0.2	N/A	N/A
Emissivity		0.9	0.9	N/A

* Test Bar Size: 3.2 x 6.4 x 50.8 mm (1/8" x 1/4" x 1/2")

** Knoop 1000-gm load

*** Dependent upon dopants in Hexoloy SA SiC that will decrease electrical resistivity to a desired range.

† Estimated.

Hexoloy®
SiC Material
Grades - A
Growing
Family

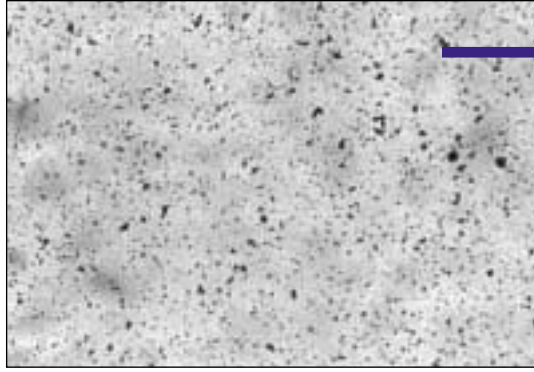

(200x)

Hexoloy SA Silicon Carbide

Hexoloy SA SiC is a pressureless, sintered form of alpha silicon carbide, with a density greater than 98 percent theoretical. It has a very fine grain structure (8 microns) for excellent wear resistance and contains no free silicon, which makes it highly chemically resistant in both oxidizing and reducing environments.

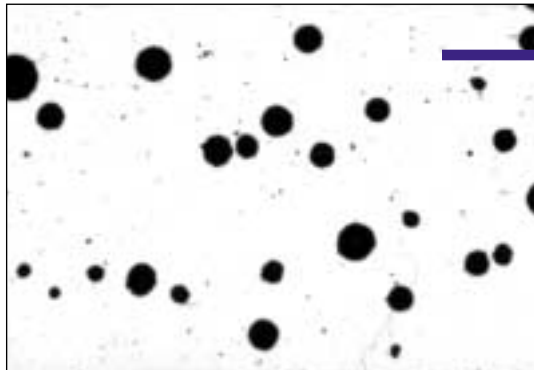

(50x)

Hexoloy SP Silicon Carbide

Hexoloy SP SiC is a sintered alpha silicon carbide material designed specifically for optimum performance in sliding contact applications such as pump seal faces and product lubricated bearings. This material improves upon the exceptional friction properties of Hexoloy SA SiC (sintered alpha SiC) through the addition of spherical pores.

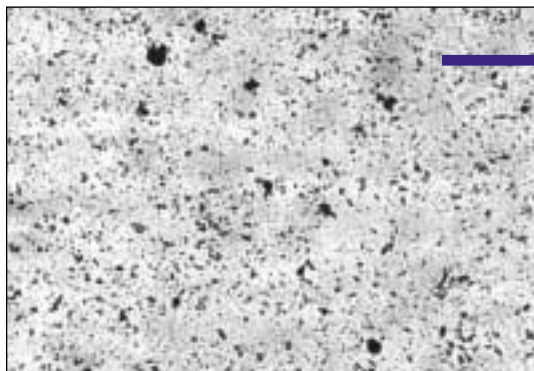

(200x)

Hexoloy SG Silicon Carbide

Hexoloy SG SiC is a unique, patented analogue of Hexoloy SA SiC. It is a sintered silicon carbide and has no free silicon metal. It is electrically conductive, permitting DC-magnetron sputtering rates approximately half that of aluminum. It also has excellent thermal conductivity.

Hexoloy® SiC Ceramic Product Applications

Automotive Components and Seal Faces

Hexoloy SA and SP SiC seal faces for automotive water pumps are replacing seal faces now made of materials such as aluminum oxide. Because of greater resistance to both wear and thermal shock, Hexoloy SA SiC has proven more suitable in meeting the performance demands of U.S. and European vehicles – lasting the lifetime of the vehicle without leaking. Carborundum currently supplies millions of seal faces for U.S. and European automakers. These are manufactured by conventional forming methods to meet high-volume manufacturing requirements economically.

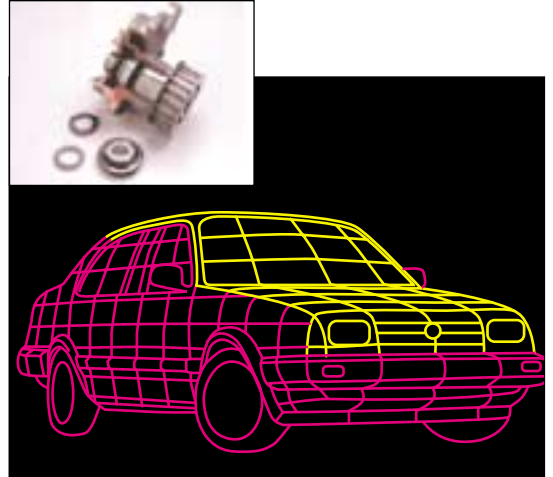

Armor

Hexoloy SA SiC has demonstrated an excellent performance record as ceramic material in composite armor protection systems. The properties of silicon carbide, such as its high hardness, compressive strength and elastic modulus, provide superior ballistic capability to defeat high-velocity projectiles. The low specific density of Hexoloy SA SiC makes it suitable in applications where weight requirements are critical. Square and rectangular shapes can be provided, and uniquely shaped geometries are produced without dense grinding.

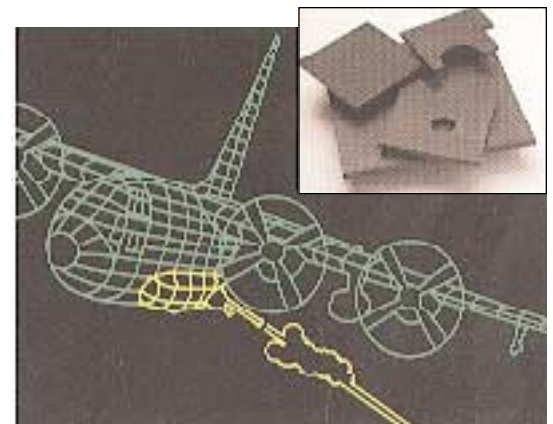

Faucet Washers

Hexoloy SA SiC is an excellent solution to fluid handling problems. In water taps, its corrosion resistance prevents salt and other deposits from forming on the sealing surface. Its excellent surface finishing characteristics plus its hardness provide a wear-resistant surface with low friction coefficients for easy valve operations. The fine microstructure of Hexoloy SA SiC also provides a pit-free surface to discourage deposits from forming and making operation difficult.

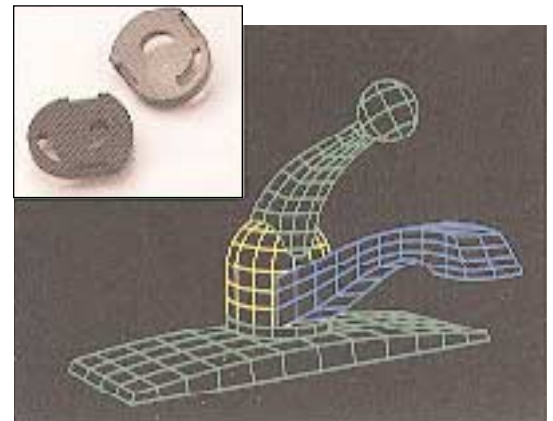

Heat Exchangers

Hexoloy SA SiC tubes are used in shell and tube heat exchangers in the chemical process industry. Hexoloy's virtually universal corrosion resistance, high thermal conductivity and high strength allow for performance which cannot be equaled by other materials. Tubes are available in a variety of diameters and in lengths of up to 14 feet.

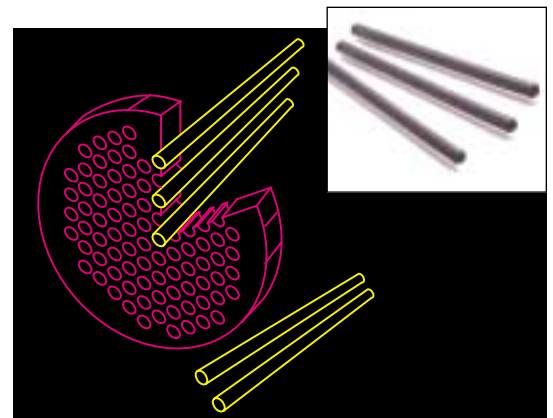

Mechanical Seals

Pumps must operate in an infinite variety of demanding environments. Hexoloy SA and SP SiC offer a high performance seal face material that has proven successful in such diverse pumping applications as chemical processing, refining, mining and pulp and paper processing. No other commercially available seal material offers the performance package Hexoloy SA and SP SiC provide: superior corrosion and abrasion resistance; shock resistance; and low sliding friction against a wide range of mating materials. This material is available in either unground or finished-ground components.

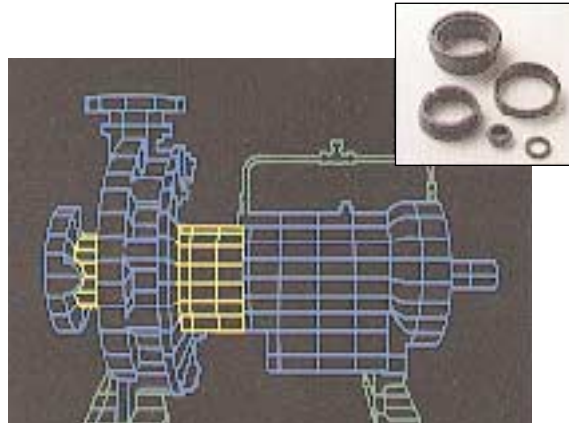

Bearings

For state-of-the-art magnetically driven pumps, Hexoloy SA and SP SiC are particularly suited for thrust and journal bearing components. Excellent corrosion resistance provides optimum performance in all chemical environments. High thermal conductivity minimizes failure due to thermal shock, and its specific strength makes it safe to use at high rotational speeds. Bearings are available as tightly toleranced precision-ground parts.

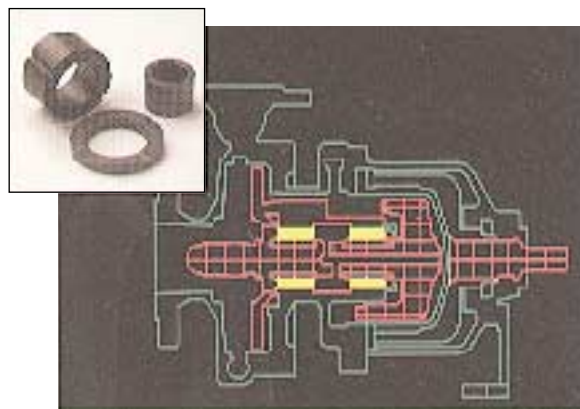

Blast and Atomization Nozzles

Hexoloy SiC is the most popular ceramic alternative in the world to tungsten carbide for blast nozzle use. Hexoloy SA provides long life (50% over WC) due to excellent wear and corrosion resistance. Less wear maintains internal nozzle geometry and provides maximum blast effectiveness, minimum compressor requirements and less frequent replacement. Hexoloy SiC is also about one fifth the weight of WC, so blasting is easier. Nozzles can be provided as finished or semifinished components.



Semiconductor Hardware

Advantages of Hexoloy SA silicon carbide for semiconductor components include thermal expansion match to silicon, resistance to wear and chemical corrosion allowing economic benefits of maintenance and reuse, high-temperature strength, and high thermal conductivity exceeding that of other high-performance ceramics and metal alloys. Hexoloy SA is well suited as a structural material for low mass silicon wafer handling components and rigid, dimensionally stable platforms due to its lightness in weight and high elastic modulus. Applications include vacuum chucks, chemical mechanical polishing blocks, wafer carriers, and thermocouple protection tubes.

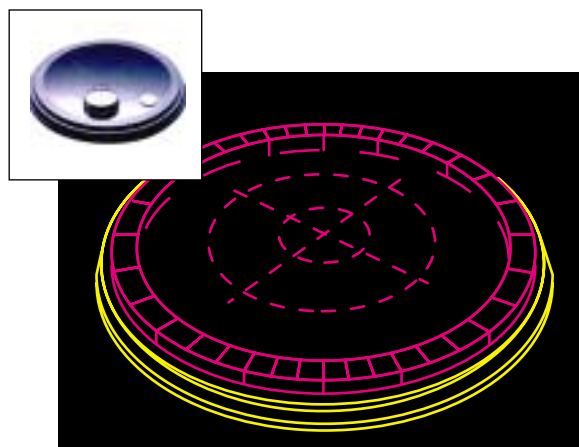

Hexoloy® SiC Ceramic Product Applications

Valve and Valve Trim

The outstanding corrosion resistance of Hexoloy SA SiC, particularly in acids, makes it an ideal candidate for valve and valve trim applications. Hexoloy is used in demanding applications such as slurry flashing, HF acid handling and rare earth processing. Check valve components can handle environments other ceramic materials cannot survive.

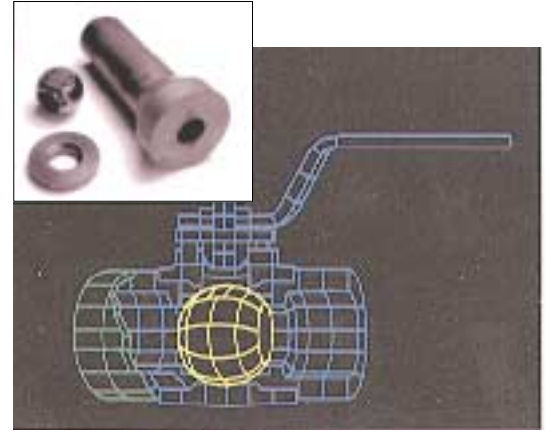

DC-Magnetron Sputtering

Hexoloy SG, a variant of SA silicon carbide containing graphitic carbon, is electrically conductive and can be readily DC magnetron sputtered. Silicon carbide thin film coatings are optically transparent, abrasion and corrosion resistant, temperature stable, and have excellent adhesion on a variety of substrates. Applications include optical data and magnetic hard disks, hard protective coatings on flat glass, and conductive or vapor barrier coatings.

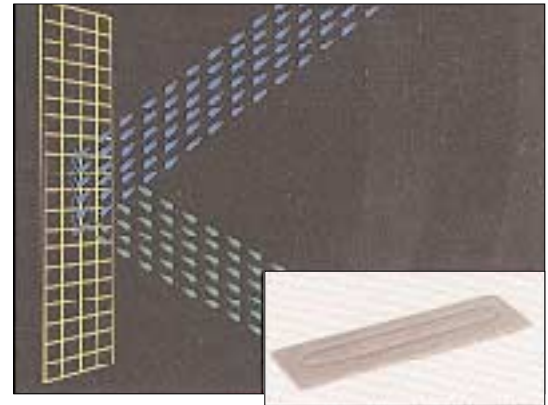

Paper Industry Products

Hexoloy SA has excellent corrosion and wear resistance properties. The material provides hard surfaces that can be machined to smooth, highly polished finishes. These finishes offer low coefficients of friction and compatibility with forming fabrics. Tiles, inserts and palm guides are available in finished and semifinished form.

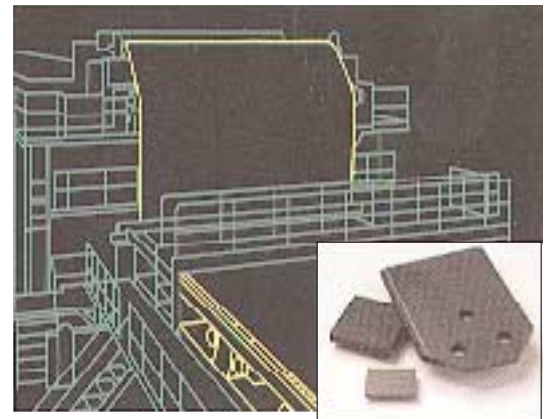

Thermal Components

For the toughest high-temperature applications, Hexoloy SA will outperform most metal, refractory and other ceramic materials. The material's low coefficient of thermal expansion and high thermal conductivity give it excellent thermal shock resistance, allowing it to survive rapid thermal cycling. At elevated temperatures, Hexoloy SiC actually increases in strength where other ceramics and metals quickly drop off. Heat-transfer components, such as immersion and recuperator tubes, are available custom made to meet customer requirements. Furnace components, such as thermocouple protection tubes, beams, rollers and burner components, are available either standard or customized.

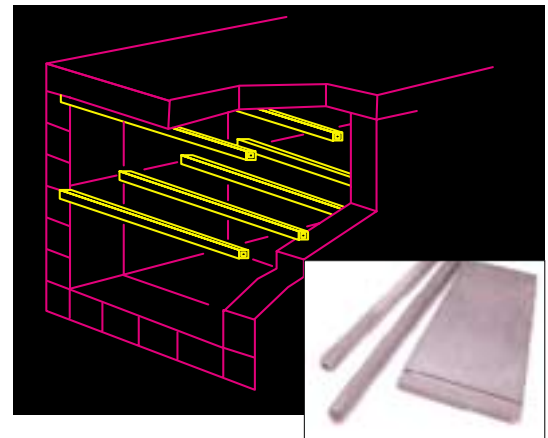

Hexoloy® SiC Fabrication Processes



Forming

Economical forming is determined by volume and tolerances of the final part. Dry pressing to size is the most economical forming method for volumes of 300 pieces or more, which help to justify the initial expense of tooling designed specifically for each part. Injection molding is used for complex parts where dry pressing isn't possible. Isostatic pressing is suited to low volumes and prototype items. Slip casting makes thin-walled uniform shapes possible for low- and medium-volume production, while extrusion is used for high-volume, constant cross-section long-length tubing and rod.



Pre-Sinter (Green) Machining

Machining in the pre-sintered, or green, state is often desirable because it allows manufacturing of finished shapes without expensive grinding of sintered material. Green machining is accomplished using conventional CNC lathes and mills. Stock removal can be accomplished 15 times faster in the green state than in the sintered state. Green machining provides parts to tolerances of ± 0.5 percent to ± 1.0 percent of their final dimensions. Typical green machined surface finishes range around 32 to 64 microinches.



Grinding/Finishing

Final grinding is done with diamond wheels and costs increase substantially as blueprint tolerances tighten. Part geometry and concentricity/parallelism also affect costs. For example, to improve outside diameter tolerances from $+0.020$ " to $+0.010$ " can increase the price by 2X. To improve from $+0.020$ " to $+0.002$ " can increase the price by 4X. Carborundum has the capability to grind to close tolerances on most shapes (± 0.0005 "). Typical ground parts hold finishes of 16 or better microinches. When surface finishes are critical to improve friction and wear performance, finishing operations such as lapping and honing can improve surfaces up to 4 microinches. Lapping and polishing can provide surface flatnesses to one helium light band.



Quality Assurance

Our company mission is to maintain the highest level of quality for our customers. Carborundum has state-of-the-art nondestructive evaluation equipment for final quality inspections of internal structures. These include bulk and surface wave ultrasonics, fluorescent dye penetrant, radiography, acoustic emission and photomicrography.

Your
Source for
Cost-Effective
Structural
Ceramics...
Worldwide.

As a part of Saint-Gobain Industrial Ceramics, Carborundum offers vast resources to meet your needs for structural ceramic/silicon carbide products. With representation in Asia by Norton KK (a Saint-Gobain company) and locations in Europe, Australia and South America, we can deliver your solution when you need it, where need you need it, in virtually every corner of the world.

You can count on Carborundum expertise to help you specify the correct structural ceramic materials to meet exacting component design criteria. Our applications engineering support team has the experience and talent to provide solutions to product design problems. Our proven manufacturing capabilities ensure world-class supply and quality assurance. Your key to cost-effective part procurement - the Carborundum structural ceramic specialists. For more information, contact one of the offices in our world-wide network.



Niagara Falls, New York
Ceramic Manufacturing Center I



Niagara Falls, New York
Ceramic Manufacturing Center II



Mönchengladbach, West Germany
Carborundum Technical Ceramics GmbH



CARBORUNDUM

United States

Carborundum Corporation
Structural Ceramics
23 Acheson Dr.
Niagara Falls, New York 14303
Telephone 716 278-6233
Fax 716 278-2373

Australia

Carborundum Resistant Materials
326 Settlement Road
Thomastown, 3074, Victoria
Melbourne, Australia
Telephone 61-3-463-0211
Fax 61-3-465-6015

Brazil

Carborundum, S.A.
Rua Santos Dumont, 111
13280 Vinhedo, São Paulo, Brazil
Telephone 55-192-76-3300/3555
Fax 55-192-76-3620

Germany

Carborundum Technical Ceramics GmbH
Postfach 401254 • Nobelstrasse 6
41189 Mönchengladbach, Germany
Telephone (0 21 66) 5 50 90
Fax (0 21 66) 5 50 910

United Kingdom

The Carborundum Company Limited
Mill Lane, Rainford, St. Helens,
Merseyside WA11 8 LP England
Telephone: 01744 882941
Fax: 01744 884842

Sales Offices in Asia

Japan

Norton KK
3-7, Kojimachi Chiyoda-Ku, Tokyo 102 Japan
Telephone: 81-3-3263-0282
Fax: 81-3-3264-6010

Korea

Norton KK
14Th, Fl. Dongshin Bldg., 141-28
Samsung-Dong, Kangnam-Ku, Seoul 135-090
Telephone: 82-2-538-7367
Fax: 82-2-538-7368

China

Norton KK
Unit 318, Yi Xiang Bldg., 1599 Yanan Rd. (W)
Shanghai 200 050 China
Telephone: 86-21-6213-7691
Fax: 86-21-6213-7692

Singapore

Norton KK
47 Gul Circle, Jurong Town
Singapore 629580
Telephone: 65-861-9880/65-861-8849
Fax: 65-861-5821

Taiwan

Norton KK
8F-3, 142, Ming-Chuan East Road
Section 3, Taipei Taiwan R.O.C.
Telephone: 886-2-717-2207
Fax: 886-2-718-0929

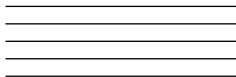

SAINT-GOBAIN
INDUSTRIAL CERAMICS

The information, recommendations and opinions set forth herein are offered solely for your consideration, inquiry and verification and are not, in part or total, to be construed as constituting a warranty or representation for which we assume legal responsibility. Nothing contained herein is to be interpreted as authorization to practice a patented invention without a license.